

ATLANTIC AVITAILLEMENT PRODUCTS.

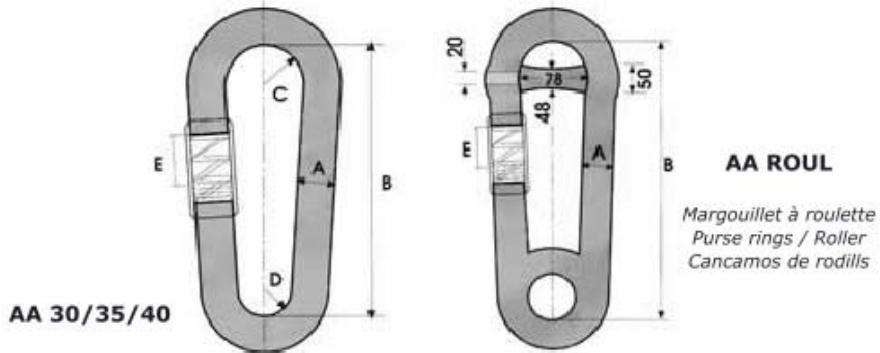

Products	Kg/ unit	Dimensions				
		A mm	B mm	C mm	D mm	E mm
AA 30mm	3,85	95	80	250	50	48
AA 35mm	5,15	115	80	285	50	50
AA 40mm	6,80	155	120	334	66	75
AA ROUL	6,40	148	100	323	50	40

*Nous proposons aussi les rechanges pour chacun des margouillots AA.
 We also provide the spare parts for the purse rings AA.
 Proponemos también piezas de recambio por los cancamos AA.*



INOX - BOSS PRODUCTS (made in Norway).

SERRURE A CARGUER



BK 11

CIERRE DE SALABARDO

Extérieur: Laiton
Intérieur: Inox

Box: Brass
Inner parts: Stainless steel

A fuera: Laton
A dentro: Acero inoxidable

BRAILING NET LOCK



BK 12

Products	Kg/unit	Dimensions				CMU / WLL kg.
		A mm	B mm	C mm	D mm	
BK 11	3,7	106	226	17	20	800
BK 12	8,3	163	377	40	29	900

BK 11

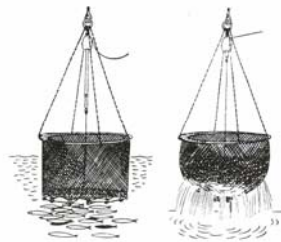
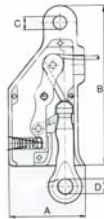

BK 12

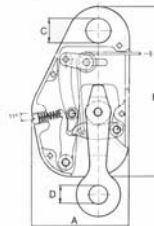

LARGUEUR DE CUL



TRAWL RELEASE

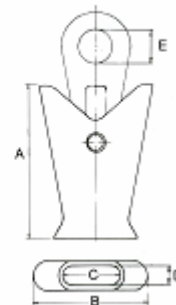

INOX / STAINLESS / INOXIDABLE
BOSS 7-12 S - BOSS 12-16 S - BOSS 16-20 S

Products	Kg/unit	Dimensions				
		A mm	B mm	C mm	D mm	E mm
BOSS 7-12 mm	0,4	79	60	29	15	17
BOSS 12-16mm	1,6	147	99	55	20	35
BOSS 16-20mm	1,9	167	98	65	24	40

INOX - BOSS PRODUCTS (made in Norway).



CHOKER HOOK

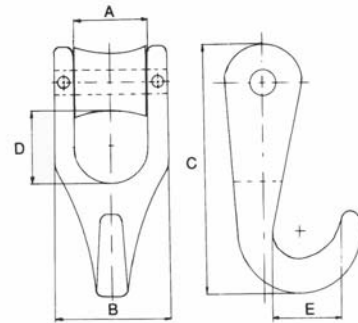

Products	Kg/unit	Dimensions					CMU / WLL (t).
		A mm	B mm	C mm	D mm	E mm	
CH 10 S	2,8	50	78	178	50	47	12
CH 11 S	8,3	69	100	234	63	56	18
CH 12 S	10,2	90	130	291	72	75	25

Aussi disponibles... Contactez nous!
Also available... Contact us!
También disponibles... ¡Contactarnos!



INOX - BOSS PRODUCTS (made in Norway).

MAILLE BOSS



ESLABON BOSS

DL 18 S - DL 22 S

SPLIT LINK

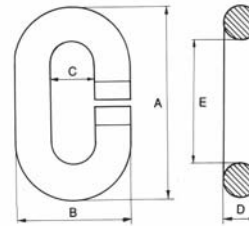

Products	Kg/unit	Dimensions					Charge de rupture Breaking load Carga de ruptura (t)	CMU SWL (t)
		A mm	B mm	C mm	D mm	E mm		
DL 18 S	1.80	76	44	18	15	50	1.0	0.2
DL 19 S	2.90	80	51	24	19	49	2.0	0.4
DL 20 S	3.20	83	56	23	18	49	3.0	0.5
DL 21 S	6.35	113	65	23	24	70	7.0	1.4
DL 22 S	6.10	110	74	23	23	70	6.5	1.3



DL 26 S - DL 28 S

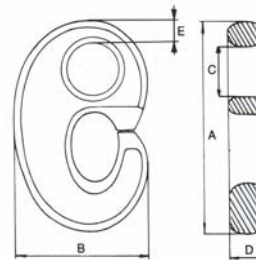

Products	Kg/unit	Dimensions					Charge de rupture Breaking load Carga de ruptura (t)	CMU SWL (t)
		A mm	B mm	C mm	D mm	E mm		
DL 26 S	1.70	150	95	39	28	16	12	2.4
DL 27 S	3.70	212	130	58	33	23	25	5.0
DL 28 S	9.80	260	163	61	49	29	60	12.0

*Aussi disponibles... Contactez nous!
Also available... Contact us!
También disponibles... ¡Contactarnos!*

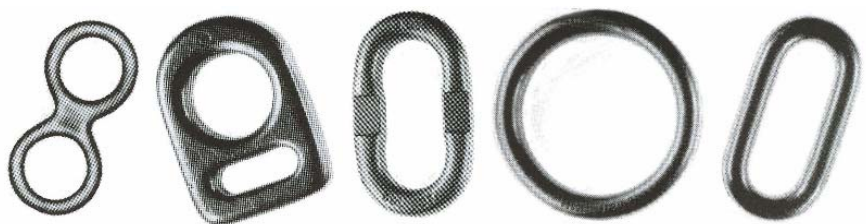

INOX - BOSS PRODUCTS (made in Norway).



MANILLE LYRE
BOULONNEES

BOLT TYPE
ANCHOR
SHACKLE

GRILLETE TIPO
ANCLA CON
PERNO

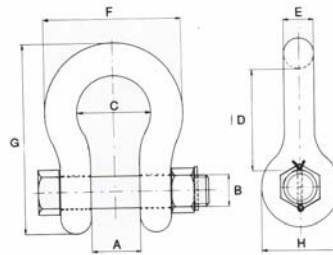

INOX / STAINLESS / INOXIDABLE

Products	Kg/unit	Dimensions								CMU SWL (t)
		A mm	B mm	C mm	D mm	E mm	F mm	G mm	H mm	
B 3 S	0,6	29	19	40	70	15	70	100	39	3
B 6 S	2,4	38	25	58	84	27	111	150	62	6
B 8 S	3,8	50	33	75	114	31	138	195	70	8
B 10 S	5,5	50	37	84	119	34	150	210	82	10
B 15 S	9,5	64	44	101	141	42	185	256	101	15
B 25 S	16,0	79	51	131	180	56	225	319	114	25

MANILLE DROITE



CHAIN
SHACKLE

GRILLETE PARA
CADENA

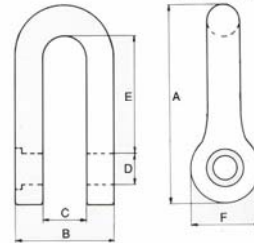

INOX / STAINLESS / INOXIDABLE

Products	Kg/ unit	Dimensions						Charge de rupture Breaking load Carga de ruptura (t)	CMU SWL (t)
		A mm	B mm	C mm	D mm	E mm	F mm		
SL 10 S	0,5	106	54	28	20	65	37	17	3
SL 11 S	0,8	122	62	27	20	70	43	15	3
SL 12 S	1,5	136	74	34	24	73	57	30	6
SL 14 S	2,6	160	88	42	33	86	68	50	10

FREKHAUG BOSS PRODUCTS (made in Norway).



Boss 40 SR
Ouverture latérale
Sideways opening
Apertura lateral



Boss 50 SR
Ouverture latérale
Sideways opening
Apertura lateral



Boss 80 SR
Ouverture latérale
Sideways opening
Apertura lateral

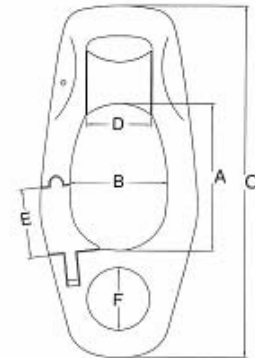

Products	Kg/ unit	Dimensions					
		A mm	B mm	C mm	D mm	E mm	F mm
BOSS 40 SR	3,9	95	80	250	50	48	48
BOSS 50 SR	4,8	115	80	285	50	50	50
BOSS 80 SR	8,4	155	120	334	66	75	48
BOSS 90 SR	7,8	148	100	323	50	40	56
BOSS 100 SR	8,4	190	120	365	50	50	53



Boss 90 SR
Ouverture rentrante
Inwards opening
Apertura adentro



Boss 100 SR
Ouverture rentrante
Inwards opening
Apertura adentro

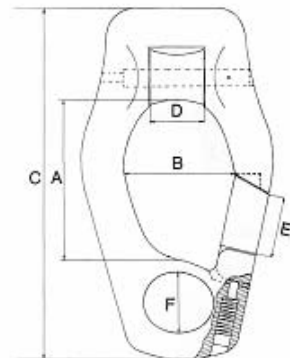
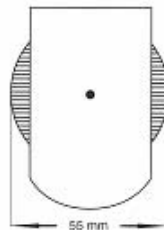



BOSS Serie 200

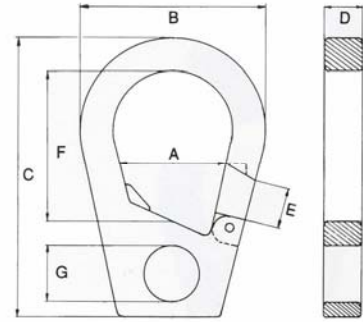

Products	Kg / Unit	Dimensions						
		A mm	B mm	C mm	D mm	E mm	F mm	G mm
BOSS 220 S	2,1	75	130	202	24	40	100	39
BOSS 230 S	3,0	94	148	235	27	49	120	45
BOSS 240 S	4,2	105	170	260	31	53	137	50
BOSS 250 S	4,7	106	170	265	35	53	137	52
BOSS 260 S	6,2	108	174	270	43	53	140	53
BOSS 285 S	8,5	119	185	278	53	55	143	53



BOSS Serie 300

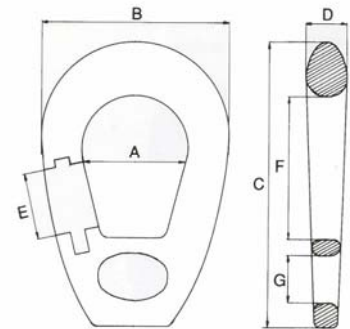

Products	Kg / Unit	Dimensions						
		A mm	B mm	C mm	D mm	E mm	F mm	G mm
BOSS 365 S	6,6	115	200	297	42	65	148	52
BOSS 370 S	7,0	123	208	347	41	76	205	54